



AUTO VENT SHADE™

Headlight Covers

For proper installation and best possible fit, please read all instructions **BEFORE** you begin.
For technical assistance or to obtain missing parts, please call Customer Relations at 1-800-241-7219.

Important Safety Information



- CAUTION - Before driving, ensure that the headlight covers are properly secured to vehicle.
- Do not use automatic “brush-style” car washes.
- Do not use cleaning solvents of any kind.
- Periodically check that all components are secured.

TO CONFORM WITH FEDERAL & STATE/LOCAL LAWS, HEADLIGHT COVERS ARE INTENDED FOR SHOW, COMPETITION, AND OFF-ROAD USE ONLY.

Contents NOTE: Actual product may vary from illustration.

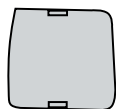

Driver Side Headlight Cover

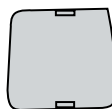

Passenger Side Headlight Cover

Tools Required



Car Wash Supplies



Clean Towel



Alcohol Pad x2

Preparation Before Painting / Installation

- A trial fit is recommended to ensure proper positioning and fit.
- Check fit of parts before painting as we will not accept the return of modified or painted parts.
- Wash your vehicle’s headlight assembly to remove any debris and/or dirt.
- Dry the headlight assembly with a clean towel.

Installation Steps NOTE: Actual application may vary slightly from illustrations.

Clean the driver side headlight assembly.

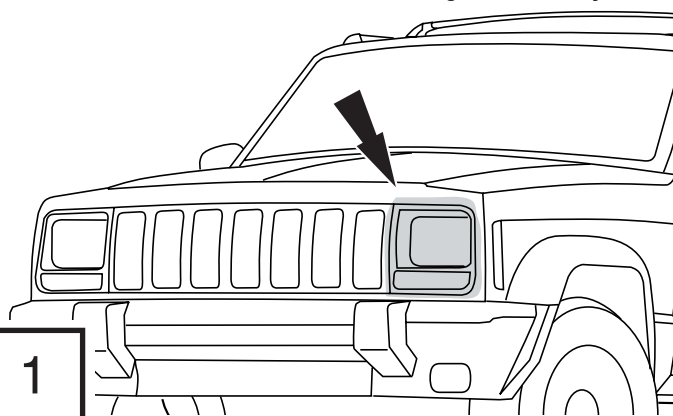

1



Align the cover with the headlight assembly. Note dual lock mounting locations and clean with alcohol pads.

Dual-lock

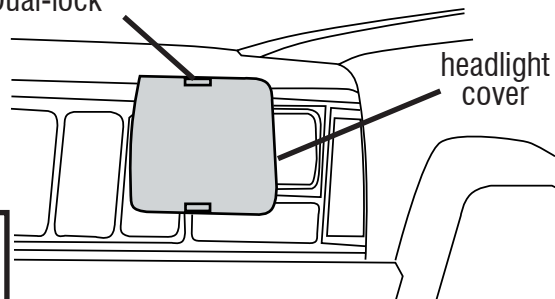

headlight cover

2

Installation Steps

NOTE: Actual application may vary slightly from illustrations.

Remove liner from dual lock strips.

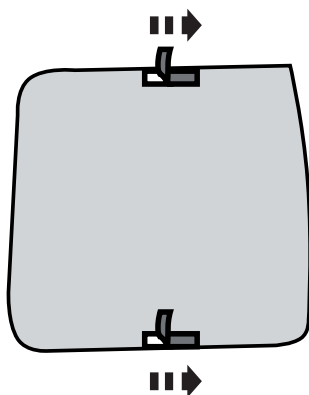

3

Adhere dual locks to previously cleaned headlight trim. Press on the front of cover to ensure headlight cover is securely in place.

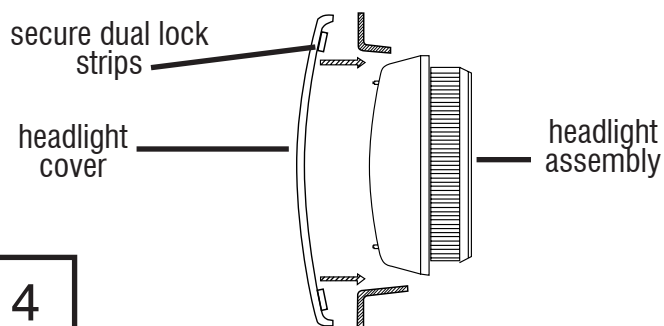

4

Repeat steps 1-4 for the passenger side.

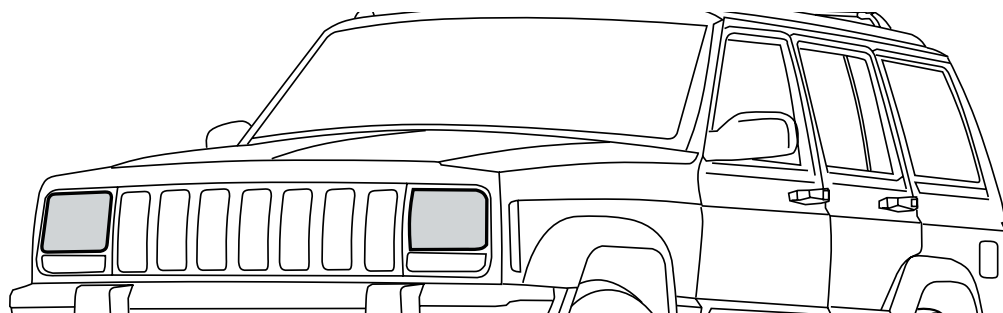

TO REMOVE HEADLIGHT COVER

Use finger to pull out edge of cover to release Dual-Lock.

Care and Cleaning

- Wash only with mild soap & dry with a clean cloth.

Warranty

Unconditional Lifetime Warranty: Auto Ventshade Headlight Covers are warranted to be free of manufacturer's defects. Neither seller or manufacturer shall be liable for any injury, loss or damage, direct or consequential, arising out of use of this product. User assumes all risk liability whatsoever in connection with this product.

Auto Ventshade requires the retention of these instructions for as long as you own avs headlight covers. Auto Ventshade also requires that you transfer instructions to any subsequent owner of the vehicle that uses these covers. Failure to transfer these instructions may void all warranties associated with the headlight covers.

Congratulations!

You have purchased one of the many quality Auto Ventshade™ branded products offered by Lund International, Inc. We take the utmost pride in our products and want you to enjoy years of satisfaction from your investment. We have made every effort to ensure that your product is top quality in terms of fit, durability, finish and ease of installation.



AUTO VENTSHADE™

Lund International, Ventshade Accessories Division

655 Raco Drive, Lawrenceville, GA 30045

800-241-7219 • Fax 770-339-5839 • Visit us at lundinternational.com



© 2005 Lund International, Inc. All rights reserved.

Auto Ventshade™, the Auto Ventshade™ logo and the AVS™ logo are trademarks of Lund International, Inc.





AUTO VENTSHADE™

Headlight Covers

Pour obtenir une installation correcte et le meilleur ajustement possible, lire toutes les instructions AVANT de commencer.

Pour toute assistance technique ou obtention de pièces manquantes, appeler le service des relations avec la clientèle au 1-800-241-7219.

Informations importantes concernant la sécurité



- ATTENTION - Avant de conduire, s'assurer que les caches de phares sont bien fixés au véhicule.
- Ne pas utiliser les stations de lavage de voitures à brosses.
- Ne pas utiliser de solvants.
- Vérifier régulièrement que toutes les pièces sont bien fixées.

POUR LA CONFORMITÉ AUX LOIS FÉDÉRALES, PROVINCIALES ET LOCALES, LES CACHES DE PHARE NE DOIVENT ÊTRE UTILISÉS QUE POUR LA DÉMONSTRATION, LA COMPÉTITION ET LA CONDUITE HORS ROUTE.

Contenu

REMARQUE : Le produit peut être différent de celui représenté sur l'illustration.

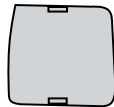

Cache de phare côté conducteur

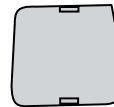

Cache de phare côté passager

Outils nécessaires



Fournitures pour lavage de voiture



Serviette propre



Tampons à l'alcool (2)

Préparation pour la peinture/l'installation

- Il est recommandé de procéder à un essai pour s'assurer que le positionnement et l'ajustement sont corrects.
- Vérifier l'ajustement des pièces avant de peindre, car nous n'acceptons pas le retour de pièces modifiées ou peintes.
- Laver les phares du véhicule pour éliminer toute poussière et tous débris.
- Sécher les phares avec une serviette propre.

Étapes d'installation

REMARQUE : La méthode d'application peut être légèrement différente de celle représentée par les illustrations.

Clean the driver side headlight assembly.

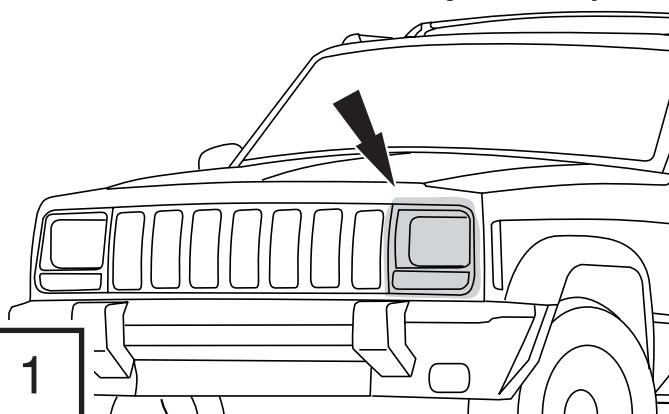

1



Align the cover with the headlight assembly. Note dual lock mounting locations and clean with alcohol pads.

Dual-lock

headlight cover

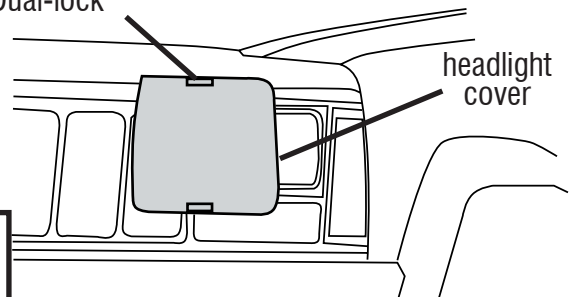

2

Étapes d'installation

REMARQUE : La méthode d'application peut être légèrement différente de celle représentée par les illustrations.

Remove liner from dual lock strips.

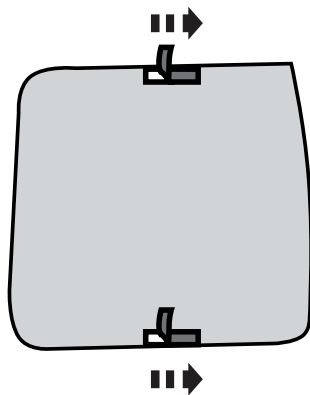

3

Adhere dual locks to previously cleaned headlight trim. Press on the front of cover to ensure headlight cover is securely in place.

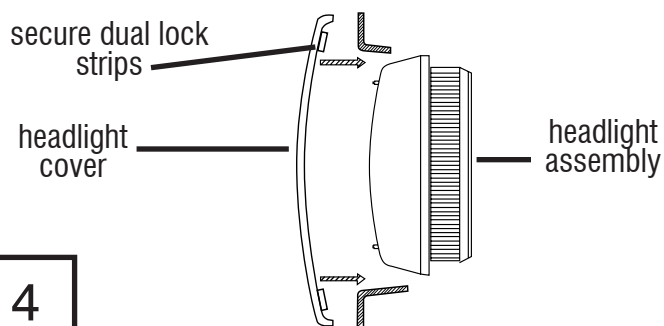

4

Repeat steps 1-4 for the passenger side.

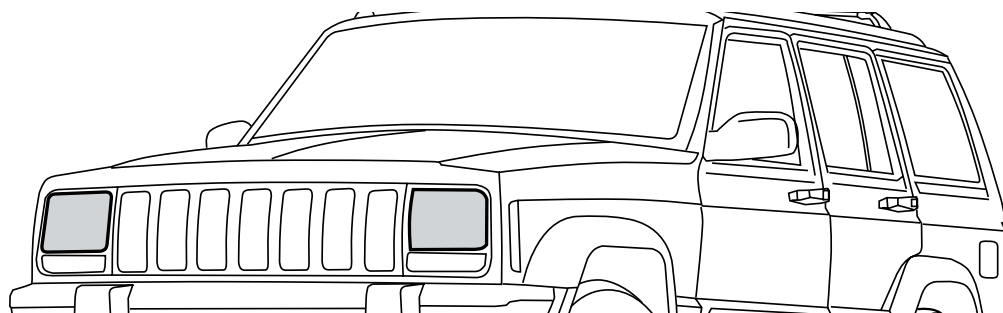

TO REMOVE HEADLIGHT COVER

Use finger to pull out edge of cover to release Dual-Lock.

Entretien et nettoyage

- Laver exclusivement avec de l'eau savonneuse et sécher avec un chiffon propre.

Garantie

Garantie inconditionnelle à vie : Les caches de phares Auto Ventshade sont garantis contre tous vices de fabrication. Ni le revendeur, ni le fabricant ne saurait être tenu responsable pour des blessures, pertes ou dommages, directs ou indirects, résultant de l'usage de ce produit. L'utilisateur assume tous les risques et responsabilités se rapportant à l'usage de ce produit.

Auto Ventshade requiert que l'utilisateur conserve ces instructions tant qu'il est en possession des caches de phares. Auto Ventshade requiert également que ces instructions soient remises à tout propriétaire ultérieur du véhicule qui utilisera ces caches. Ne pas remettre ces instructions au nouveau propriétaire peut entraîner l'annulation de toutes les garanties se rapportant aux caches de phares.

Félicitations !

Vous avez acheté l'un des nombreux produits de qualité Auto Ventshade™ fabriqués par Lund International, Inc. Nous sommes extrêmement fiers de nos produits et souhaitons que vous tiriez des années de satisfaction de votre investissement. Nous avons pris toutes les mesures nécessaires pour assurer que ce produit est d'une qualité supérieure en ce qui concerne l'ajustement, la durabilité, la finition et la facilité d'installation.



AUTO VENTSHADE™

Lund International, Ventshade Accessories Division
655 Raco Drive, Lawrenceville, GA 30045, États-Unis

800-241-7219 • Téléc. 770-339-5839 • Visitez notre site lundinternational.com



© 2005 Lund International, Inc. Tous droits réservés.
Auto Ventshade™, le logo Auto Ventshade™ et le logo AVS™ sont des marques déposées de Lund International, Inc.





Headlight Covers

Para una instalación adecuada y el mejor ajuste posible, lea todas las instrucciones ANTES de comenzar. Si desea recibir asistencia técnica u obtener piezas faltantes, llame al Servicio al cliente al 1-800-241-7219.

Información importante de seguridad



- PRECAUCIÓN - Antes de conducir, asegúrese de que las cubiertas para faros estén correctamente fijadas al vehículo.
- No utilice servicios automáticos de limpieza de vehículos que utilicen cepillos.
- No utilice limpiadores al solvente de ningún tipo.
- Compruebe periódicamente que todos los componentes estén ajustados

EN CONFORMIDAD CON LAS LEYES NACIONALES, ESTATALES Y LOCALES, LAS CUBIERTAS PARA FAROS SÓLO PUEDEN USARSE PARA EXHIBICIÓN, COMPETICIÓN Y VEHÍCULOS TODO TERRENO.

Contenido

AVISO: El producto real puede variar con respecto a las ilustraciones.

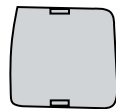

Cubierta para faro del conductor

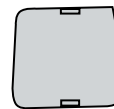

Cubierta para faro del acompañante

Herramientas necesarias



Equipo de limpieza de vehículos



Toalla limpia



Paños esterilizados (2)

Preparación antes de pintar o instalar

- Se recomienda realizar un ajuste de prueba para asegurar el posicionamiento y ajuste correctos.
- Compruebe que las piezas se ajusten correctamente antes de pintarlas, ya que no aceptaremos la devolución de piezas modificadas o pintadas.
- Lave el conjunto del faro para quitar los desechos y la suciedad.
- Seque el conjunto del faro con una toalla limpia.

Pasos de instalación

AVISO: La colocación real puede variar levemente con respecto a las ilustraciones.

Clean the driver side headlight assembly.

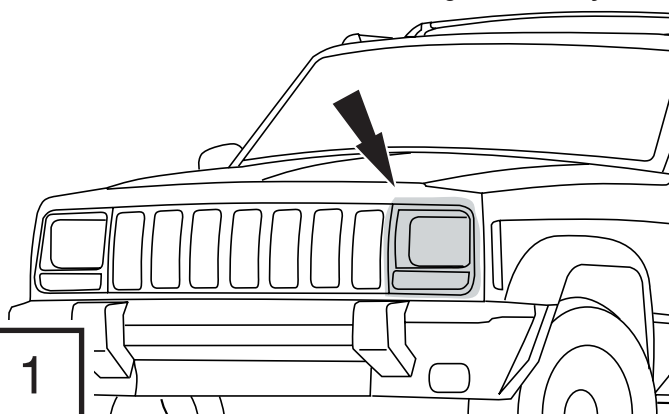

1



Align the cover with the headlight assembly. Note dual lock mounting locations and clean with alcohol pads.

Dual-lock

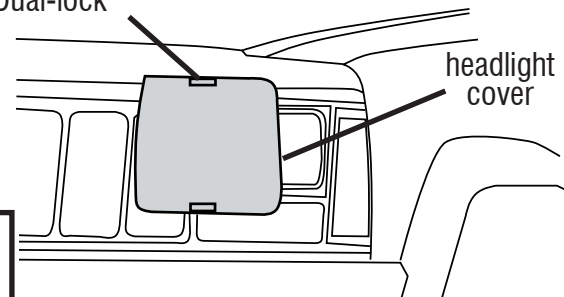

headlight cover

2

Pasos de instalación **AVISO:** La colocación real puede variar levemente con respecto a las ilustraciones.

Remove liner from dual lock strips.

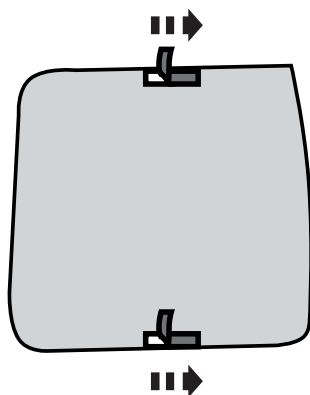

3

Adhere dual locks to previously cleaned headlight trim. Press on the front of cover to ensure headlight cover is securely in place.

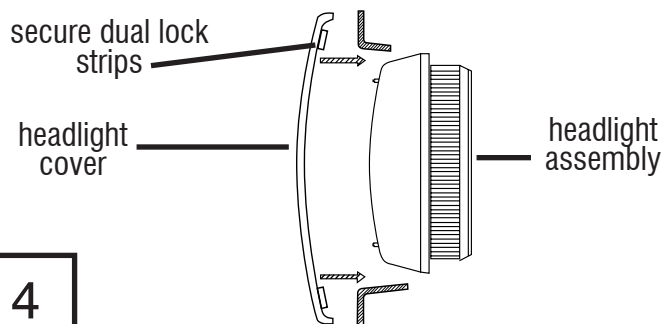

4

Repeat steps 1-4 for the passenger side.

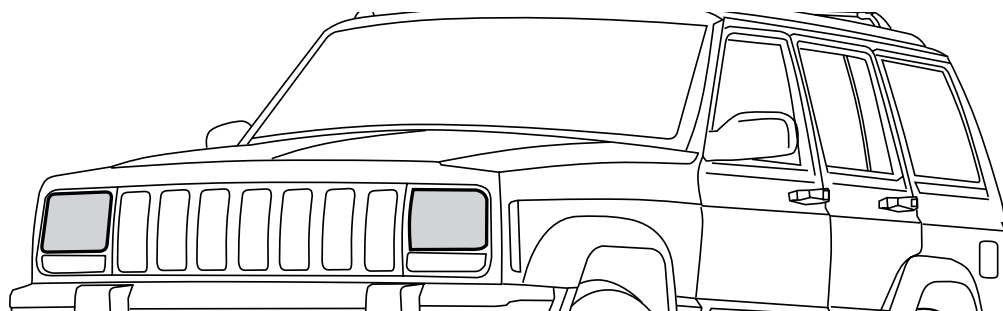

TO REMOVE HEADLIGHT COVER
Use finger to pull out edge of cover to release Dual-Lock.

Cuidado y limpieza

- Limpie solamente con agua jabonosa tibia y seque con un paño limpio.

Garantía

Garantía de por vida incondicional: Garantizamos que las cubiertas para faros de Auto Ventshade están libres de cualquier defecto de fabricación. Ni el vendedor ni el fabricante son responsables por heridas, pérdidas o daños, ya sean directos o consecuentes, que provengan del mal uso de este producto. El usuario asume todo tipo de responsabilidad en relación con este producto.

Auto Ventshade exige que se conserven estas instrucciones durante el tiempo que tenga las cubiertas para faros de AutoVentshade. Auto Ventshade también exige que se transfieran estas instrucciones al próximo dueño del vehículo que tenga colocadas las cubiertas. Si no se transfieren estas instrucciones se anularán todas las garantías asociadas con las cubiertas para faros.

Felicidades

Usted ha comprado uno de los tantos artículos de calidad de Auto Ventshade™ ofrecidos por Lund International, Inc. Nuestros productos son nuestro mayor orgullo. Deseamos que disfrute de años de satisfacción con su inversión. Hemos realizado todos los esfuerzos para asegurarnos de que su producto sea de la mejor calidad en cuanto a ajuste, durabilidad, acabado y facilidad de instalación.



AUTO VENTSHADE™

Lund International, Ventshade Accessories Division

655 Raco Drive, Lawrenceville, GA 30045

800-241-7219 • Fax 770-339-5839 • Visite nuestro sitio Web: lundinternational.com



© 2005 Lund International, Inc. Todos los derechos reservados.
Auto Ventshade™, el logo de Auto Ventshade™ y el logo de AVS™ son marcas comerciales de Lund International, Inc.

