



INSTALLATION INSTRUCTIONS

MAKE: Ford

MODEL: F-150

YEAR: 2015-2018

ENGINE: V6-2.7L (tt) / 3.5L (tt) EcoBoost

WHEELBASE: 145" CC/SB & EC/SB

4" Cat-Back Aluminized

49-03069-P (Polished Tip)

49-03069-B (Black Tip)

4" Cat-Back Stainless Steel

49-43069-P (Polished Tip)

49-43069-B (Black Tip)

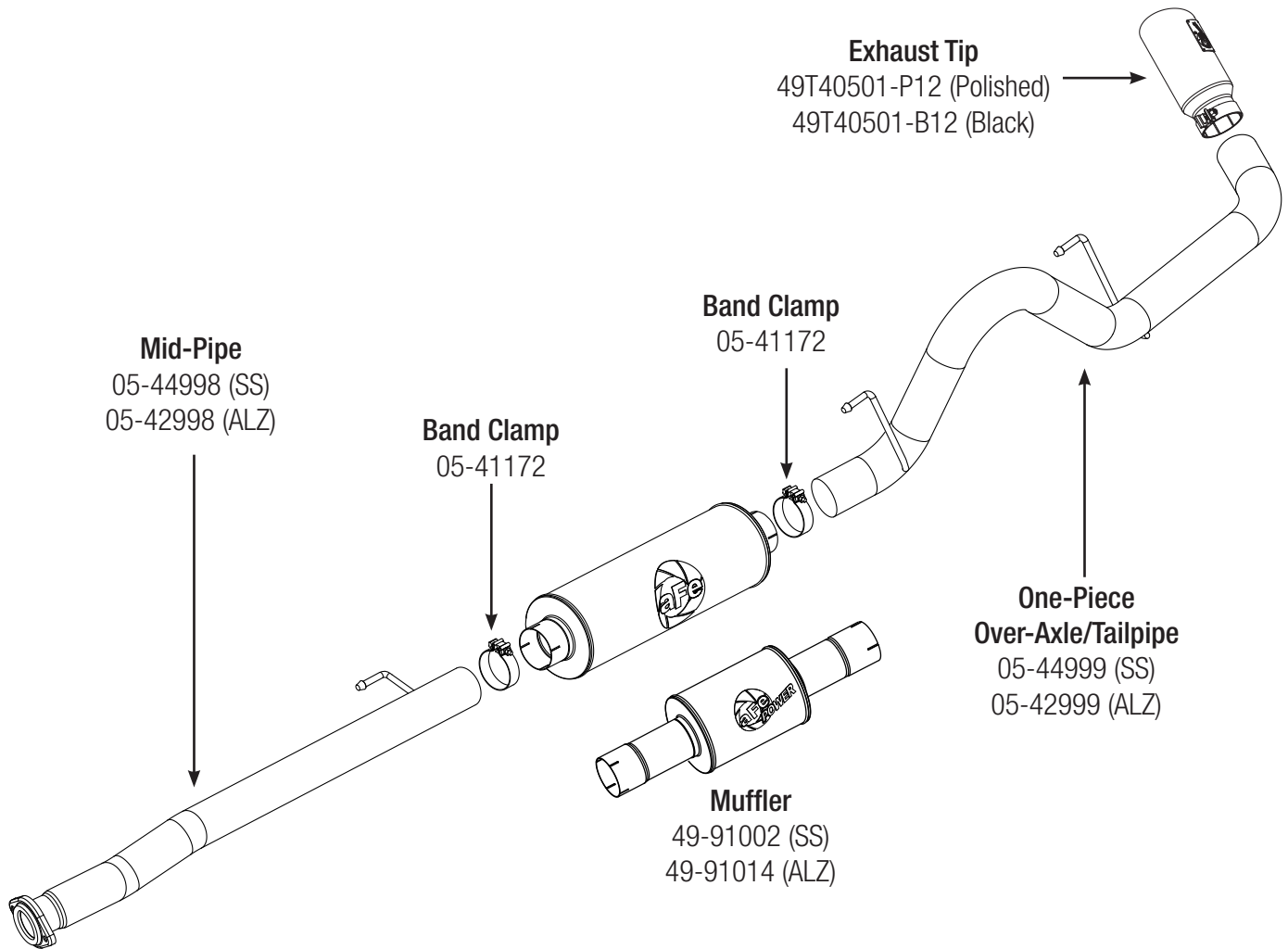

Step 1: (Read Instructions prior to installation) Remove your stock exhaust up to the catalytic converter from the rear of your truck working your way forward. Take caution not to damage the factory hardware and isolation mounts as they will be reused.

It is recommended to not fully tighten the clamps until the entire system has been installed.

Step 2: For faster installation spread the pieces of the exhaust along side of your vehicle according to the diagram shown.

Step 3: Install front mid-pipe into place.

Step 4: Install muffler, Place jack/stand under muffler for support.

Step 5: Utilizing the factory isolation mount now install the over-axle/tailpipe and tighten all clamps from front to rear.

Step 6: Your installation is now complete. It is recommended to re-tighten all exhaust components after 50-100 miles.

NOTES:

- aFe recommends that the tailpipe be at least 1/2"-1" away from any body panels to avoid heat related body damage. **Tighten and secure.**

Caution: Allow time for your vehicle to cool down prior to installation. When working on or under your vehicle proceed with caution. Exhaust systems reach high temperatures and may cause serious burns. Wear protective safety equipment; eye goggles and gloves to ensure a safe installation. **aFe recommends professional installation on our products.**